

GV4P115S

Motor circuit breaker, TeSys GV4, 3P, 115A, Icu 100kA, thermal magnetic, Everlink terminals



Main

Range	TeSys
Product name	TeSys GV4
Device short name	GV4P
Product or component type	Circuit breaker
Device application	Motor protection
Protection type	Ground fault protection Short time short-circuit protection Short-circuit Overload Phase unbalance Phase loss
Utilisation category	Category A
Suitability for isolation	Yes conforming to IEC 60947-1
Poles description	3P
[Ue] rated operational voltage	690 V AC 50/60 Hz conforming to IEC 60947-2
[In] rated current	115 A
Trip unit technology	Electronic Thermal-magnetic
Magnetic tripping current	1955 A
[I _{sd}] short-time pick-up adjustment range	13 x I _r
Thermal protection adjustment range	65...115 A
Motor tripping class	10 20
Phase failure sensitivity	Yes IEC 60947-4-1
Breaking capacity	Icu 18 kA at 525 V AC 50/60 Hz conforming to IEC 60947-2 Icu 30 kA at 500 V AC 50/60 Hz conforming to IEC 60947-2 Icu 100 kA at 380...415 V AC 50/60 Hz conforming to IEC 60947-2 Icu 10 kA at 660...690 V AC 50/60 Hz conforming to IEC 60947-2 Icu 120 kA at 220...240 V AC 50/60 Hz conforming to IEC 60947-2 Icu 70 kA at 440 V AC 50/60 Hz conforming to IEC 60947-2 100 kA at 208Y/120 V AC 50/60 Hz conforming to UL 60947 100 kA at 240 V AC 50/60 Hz conforming to UL 60947 65 kA at 480Y/277 V AC 50/60 Hz conforming to UL 60947 25 kA at 600Y/347 V AC 50/60 Hz conforming to UL 60947
[Ics] rated service breaking capacity	120 kA at 220...240 V AC 50/60 Hz conforming to IEC 60947-2 100 kA at 380...415 V AC 50/60 Hz conforming to IEC 60947-2 70 kA at 440 V AC 50/60 Hz conforming to IEC 60947-2 30 kA at 500 V AC 50/60 Hz conforming to IEC 60947-2 18 kA at 525 V AC 50/60 Hz conforming to IEC 60947-2 2.5 kA at 660...690 V AC 50/60 Hz conforming to IEC 60947-2

The information provided in this documentation contains general descriptions and/or technical characteristics of the products contained herein. This documentation is not intended as a substitute for and is not to be used for determining suitability or reliability of these products for specific user applications. It is the duty of any such user or integrator to perform the appropriate and complete risk analysis, evaluation and testing of the products with respect to the relevant specific application or use thereof. Neither Schneider Electric Industries SAS nor any of its affiliates or subsidiaries shall be responsible or liable for misuse of the information contained herein.

[Uimp] rated impulse withstand voltage	8 kV conforming to IEC 60947-2
[Ui] rated insulation voltage	800 V conforming to IEC 60947-2

Complementary

Mechanical durability	40000 cycles
Electrical durability	10000 cyclesFor AC-3 at 440 V In/2 5000 cyclesFor AC-3 at 440 V In
Motor power kW	110 kW at 660...690 V AC 50/60 Hz 37 kW at 400...415 V AC 50/60 Hz 45 kW at 400...415 V AC 50/60 Hz 45 kW at 500 V AC 50/60 Hz 55 kW at 400...415 V AC 50/60 Hz 55 kW at 500 V AC 50/60 Hz 75 kW at 500 V AC 50/60 Hz 75 kW at 660...690 V AC 50/60 Hz 90 kW at 660...690 V AC 50/60 Hz
Control type	Rotary handle
Rotary handle padlocking	Padlock in OFF or ON position
Number of slots	1 slot(s)For alarm switchFor fault signalling contact plug-in 1 slot(s)For voltage releaseFor electrical remote tripping plug-in 1 slot(s)For auxiliary switchFor open/close contact plug-in
Local signalling	Ready: flashing LED (green) Alarm (T° >95%): LED (red) Presence of auxiliary contacts: green indicator
Standards	EN/IEC 60947-4-1 EN/IEC 60947-2 UL 60947-4-1 CSA C22.2 No 60947-4-1
Quality labels	CE
Mounting mode	By clips By screws
Mounting support	35 mm symmetrical DIN rail 75 mm symmetrical DIN rail Plate
Connections - terminals	Top 1 EverLink BTR screw connectors wire size 1.5...70 mm ² solid Top 1 EverLink BTR screw connectors wire size 1.5...50 mm ² flexible Bottom 1 EverLink BTR screw connectors wire size 2.5...95 mm ² solid Bottom 1 EverLink BTR screw connectors wire size 2.5...70 mm ² flexible
Connection pitch	27 mm
Wire stripping length	20 mm
Tightening torque	9 N.mFor 16...95 mm ² 5 N.mFor 1.5...10 mm ²
Width	81 mm
Height	155 mm
Depth	165 mm
Product weight	1.6 kg
Colour	Grey (RAL 7016)

Environment

product certifications	ATEX BV CSA IEC UL EAC
ambient air temperature for storage	-50...85 °C
ambient air temperature for operation	-25...70 °C
operating altitude	0...2000 m without derating 2000...5000 m with derating
IP degree of protection	IP40 front face conforming to IEC 60529
IK degree of protection	IK07 conforming to IEC 62262
pollution degree	3 conforming to IEC 60947-1

tropicalisation	2 conforming to IEC 68-2
mechanical robustness	Vibrations: +/- 1 mm 2...13.2 Hz conforming to IEC 60068-2-6 Vibrations: 0.7 gn 13.2...100 Hz conforming to IEC 60068-2-6 Shocks: 15 gn 11 ms conforming to IEC 60068-2-27

Offer Sustainability

Sustainable offer status	Green Premium product
RoHS (date code: YYWW)	Compliant - since 1736 - Schneider Electric declaration of conformity
REACH	Reference not containing SVHC above the threshold
Product environmental profile	Available
Product end of life instructions	Available

Thermal-Magnetic Tripping Curves for GV4P, GV4PE, GV4PEM

Average Operating Times at 20 °C Related to Multiples of the Setting Current

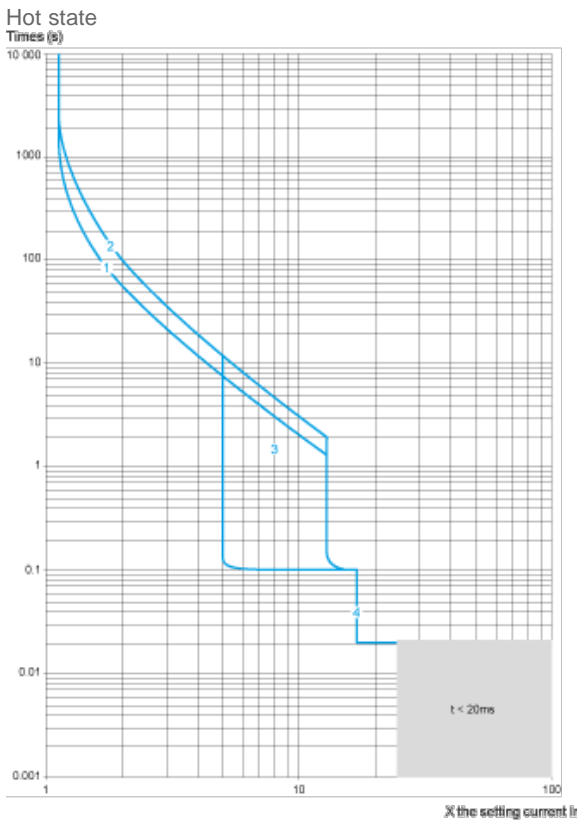

- 1 Class 10
- 2 Class 20
- 3 $I_{sd} = 5...13 \times I_r$
- 4 $I_i = 17 I_n$

Cold state

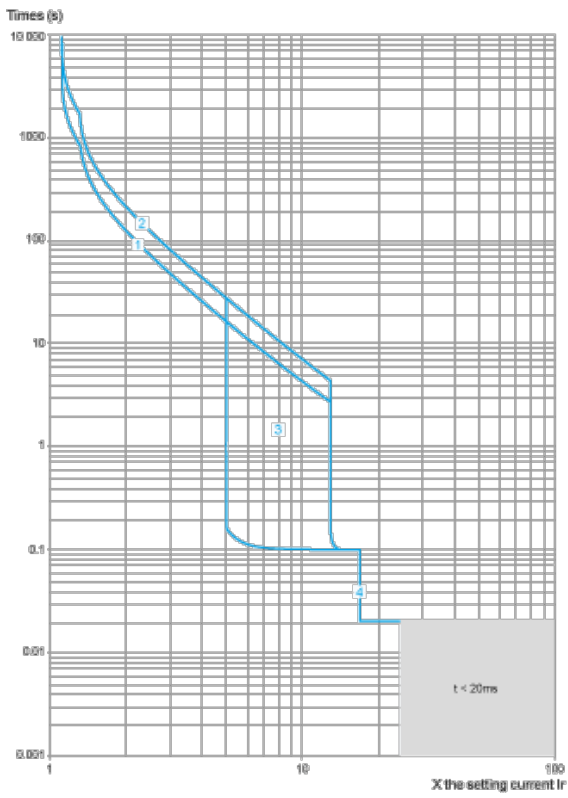

- 1 Class 10
- 2 Class 20
- 3 $I_{sd} = 5 \dots 13 \times I_r$
- 4 $I_i = 17 I_n$

Current Limitation on Short-Circuit for GV4P, GV4PE, GV4PEM (3-Phase 400/415 V)

Dynamic Stress

$I_{peak} = f(\text{prospective } I_{sc}) \text{ at } 1.05 U_e = 435 \text{ V}$

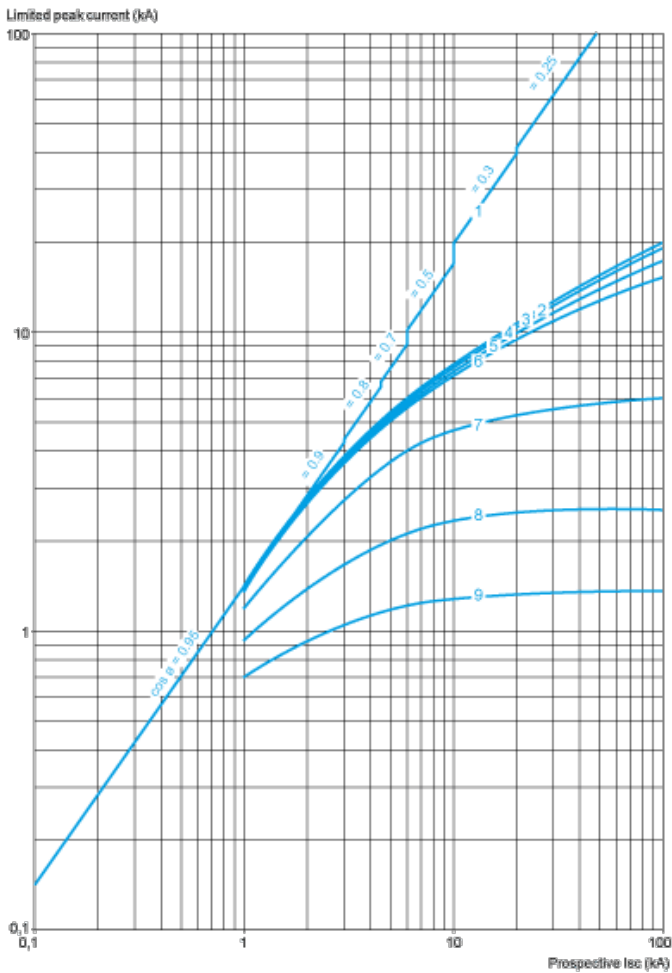

- 1 Maximum peak current
- 2 GV4P115
- 3 GV4P80
- 4 GV4P50
- 5 GV4P25
- 6 GV4P12
- 7 GV4P07
- 8 GV4P03
- 9 GV4P02

Thermal Limit on Short-Circuit for GV4P, GV4PE, GV4PEM

Thermal Limit in kA^2s in the Magnetic Operating Zone

Sum of $I^2dt = f$ (prospective I_{sc}) at $1.05 U_e = 435 V$

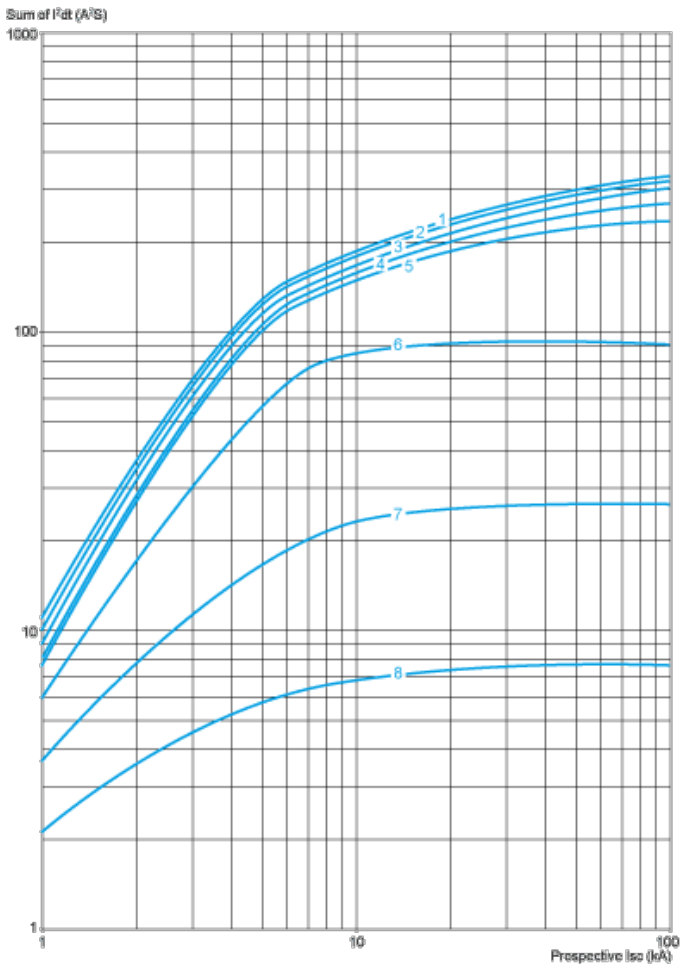

- 1 GV4P115
- 2 GV4P80
- 3 GV4P50
- 4 GV4P25
- 5 GV4P12
- 6 GV4P07
- 7 GV4P03
- 8 GV4P02

GV4 with Toggle: GV4LE, GV4PE, GV4PEM

With EverLink® Connector

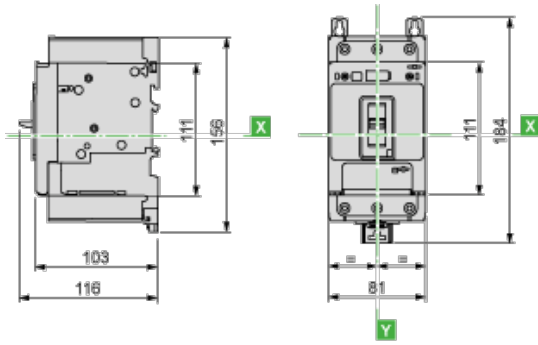

With Crimp Lug Connector

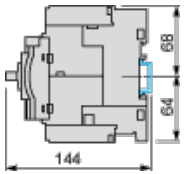

GV4 with Rotary Handle: GV4L, GV4P, or GV4LE, GV4PE, GV4PEM with GV4ADN01, GV4ADN02 Direct Mounting Rotary Handle

Dimensions

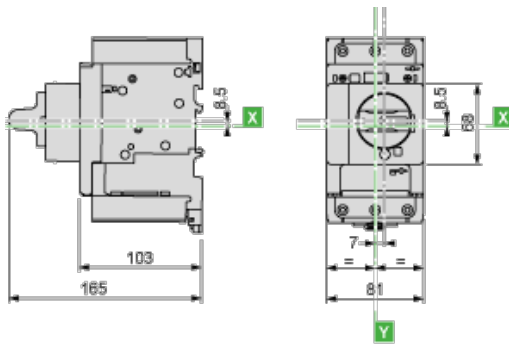

GV4L, GV4P, GV4LE, GV4PE, GV4PEM

Panel Mounting with M4 Screws

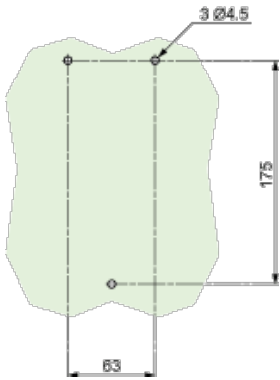

Door Cut-Out for Rotary Handle

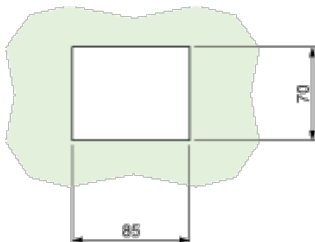

Minimum Safety Clearance

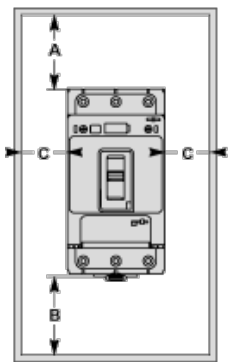

Toggle-type, rotary handle-type: identical clearance values.

Safety Clearance (mm)						
	Painted Sheet Metal			Bare Sheet Metal		
	A	B	C	A	B	C
No accessory	30	0	0	40	0	5
Interphase barriers	0	0	0	0	0	5
Long terminal shield	0	0	0	0	0	5

Magnetic Motor Circuit Breakers

GV4P, GV4PE, GV4PEM

